

3x

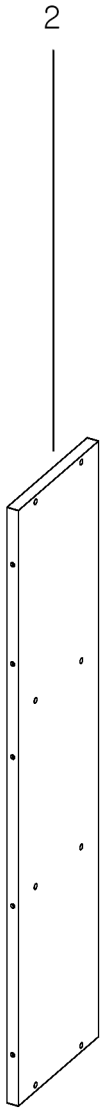

6x

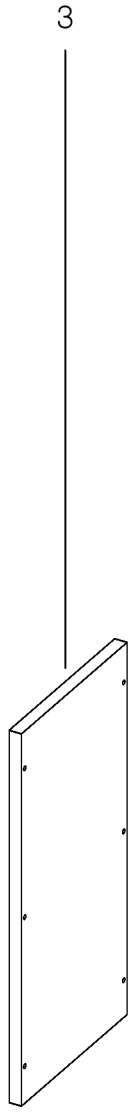

3x

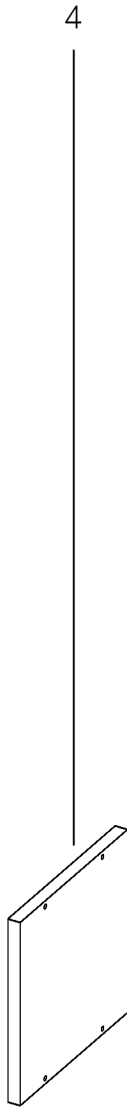

3x



1x

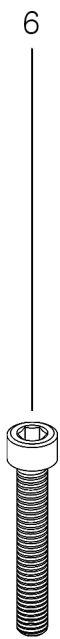

36x

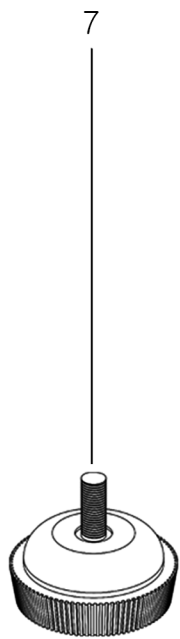

6x



2x



24x

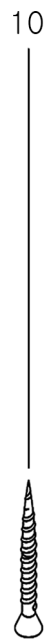

2x

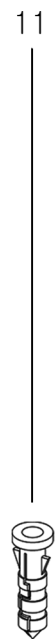

2x



4x

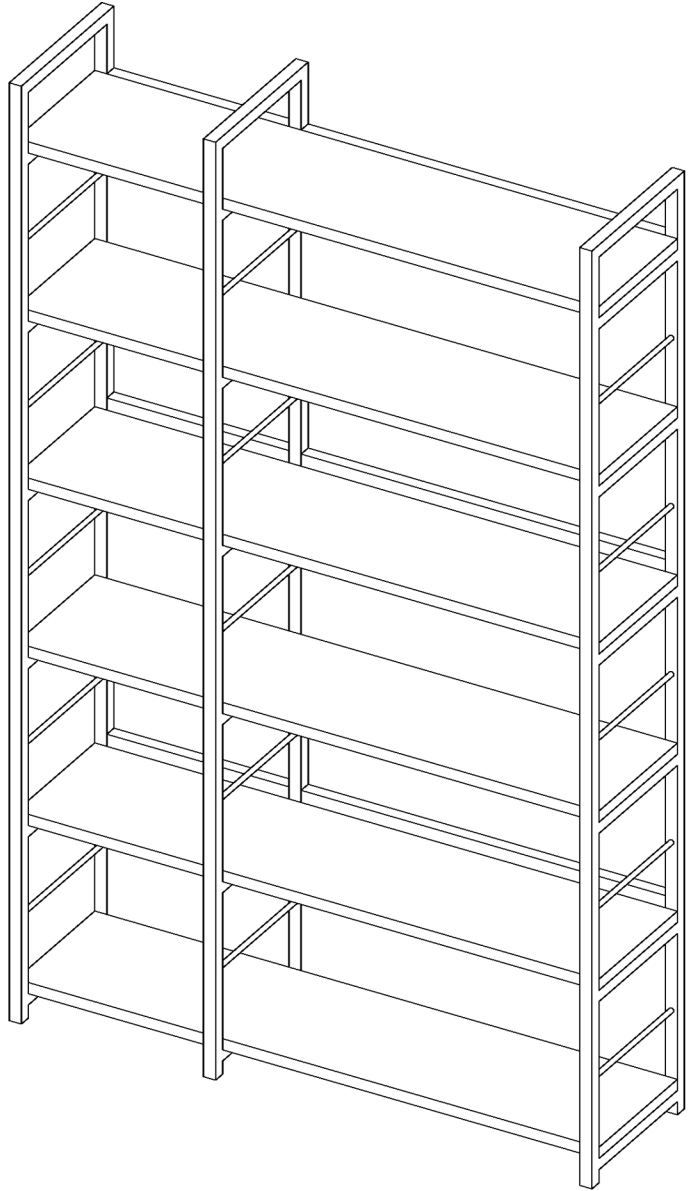
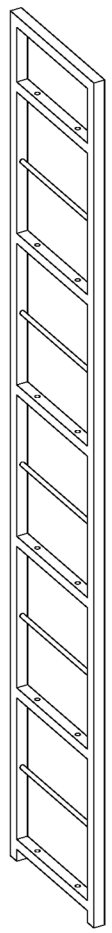
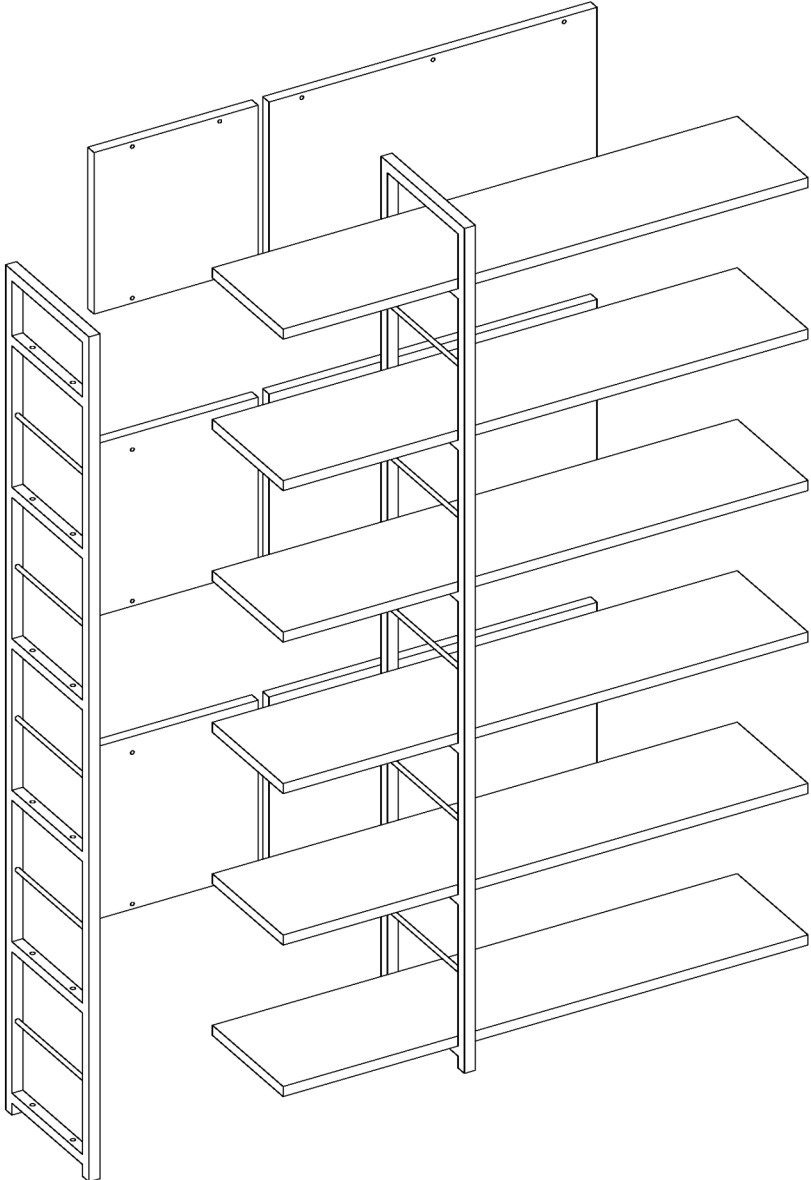

STEP 1

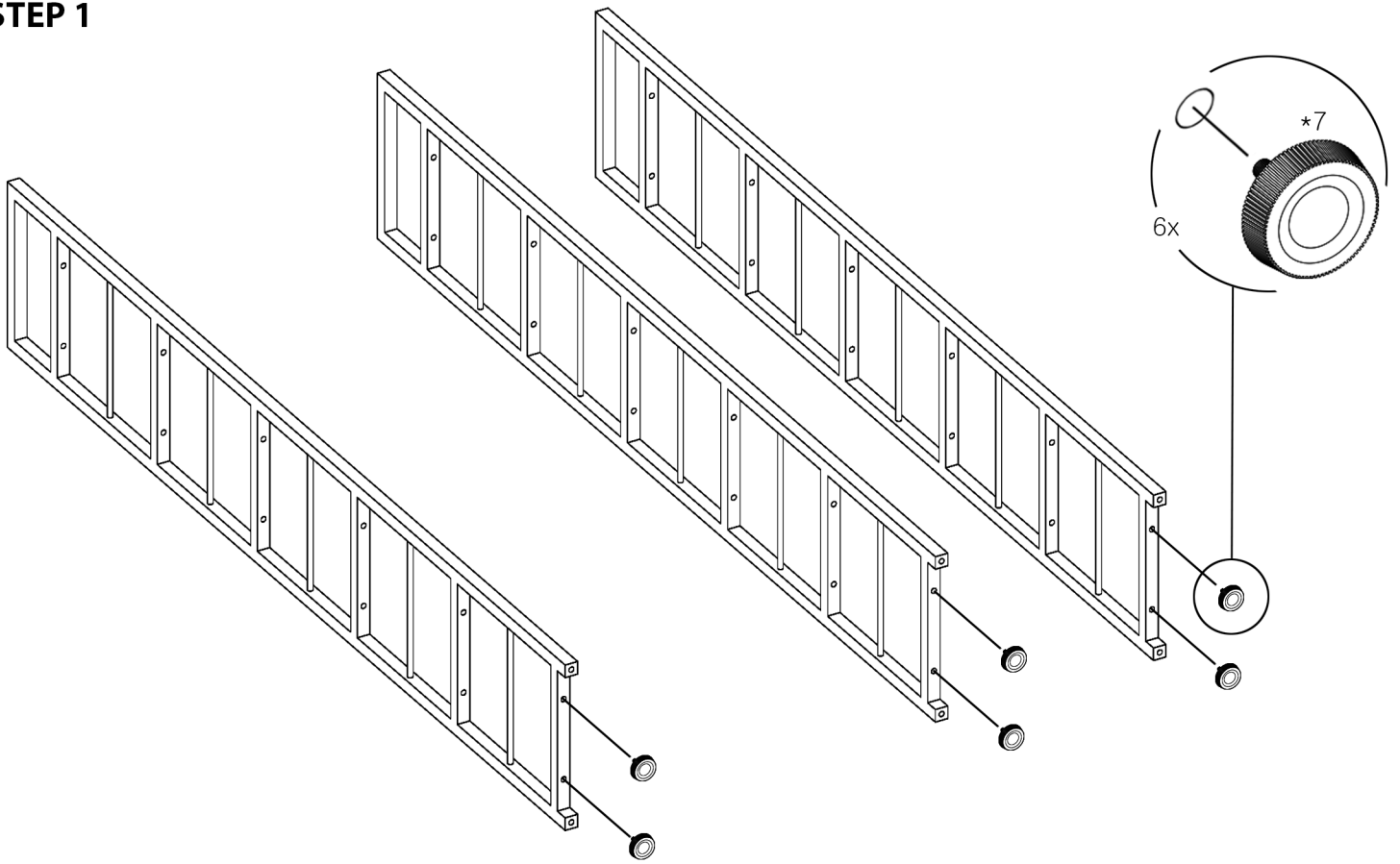

STEP 2

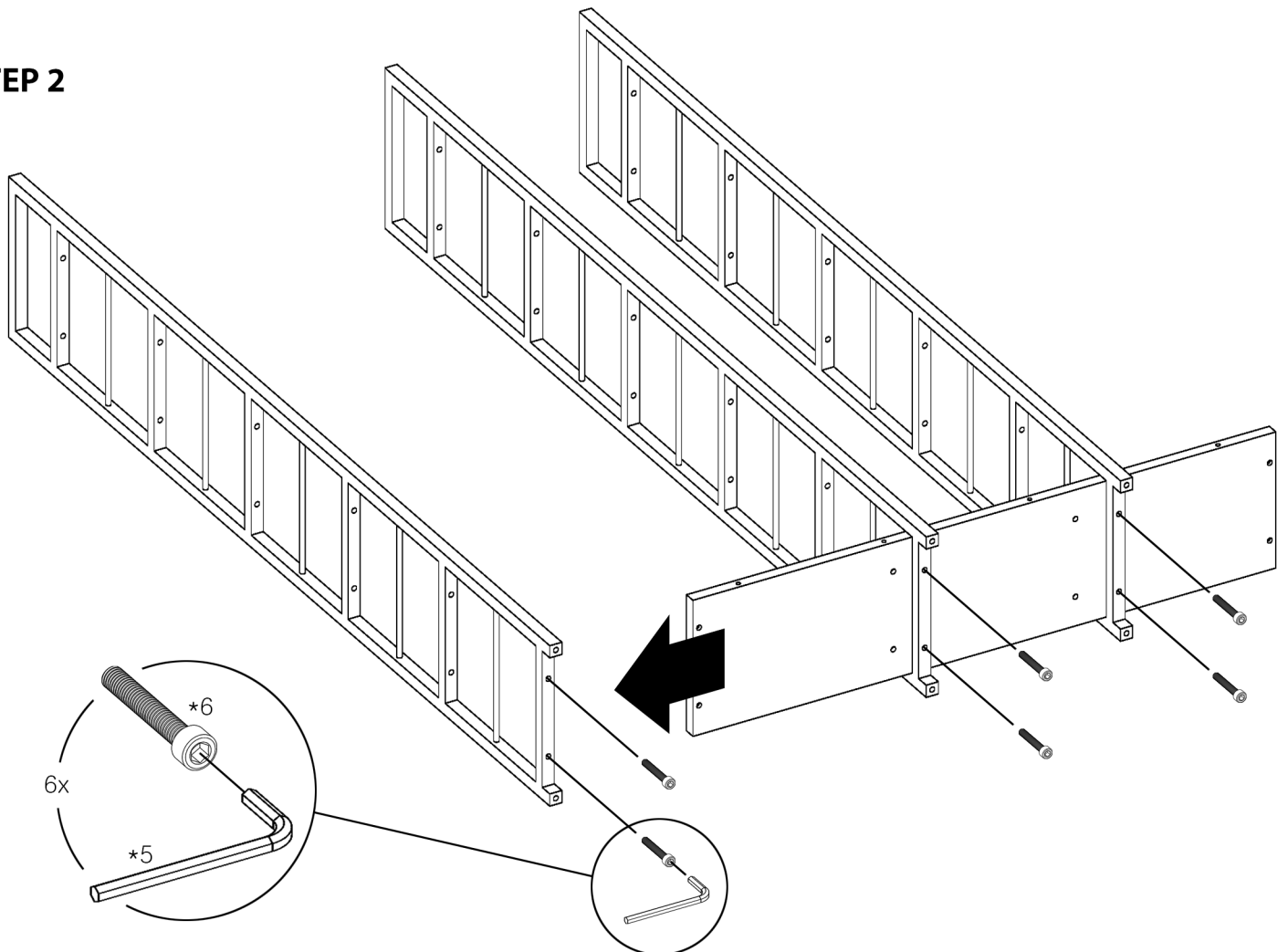

STEP 3

*중앙 뼈골을 인테리어에 맞게 좌우 선택 후 조립해주시요.

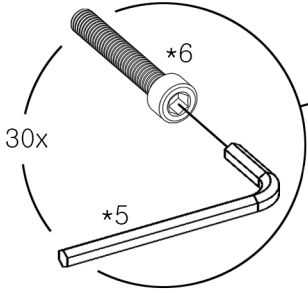
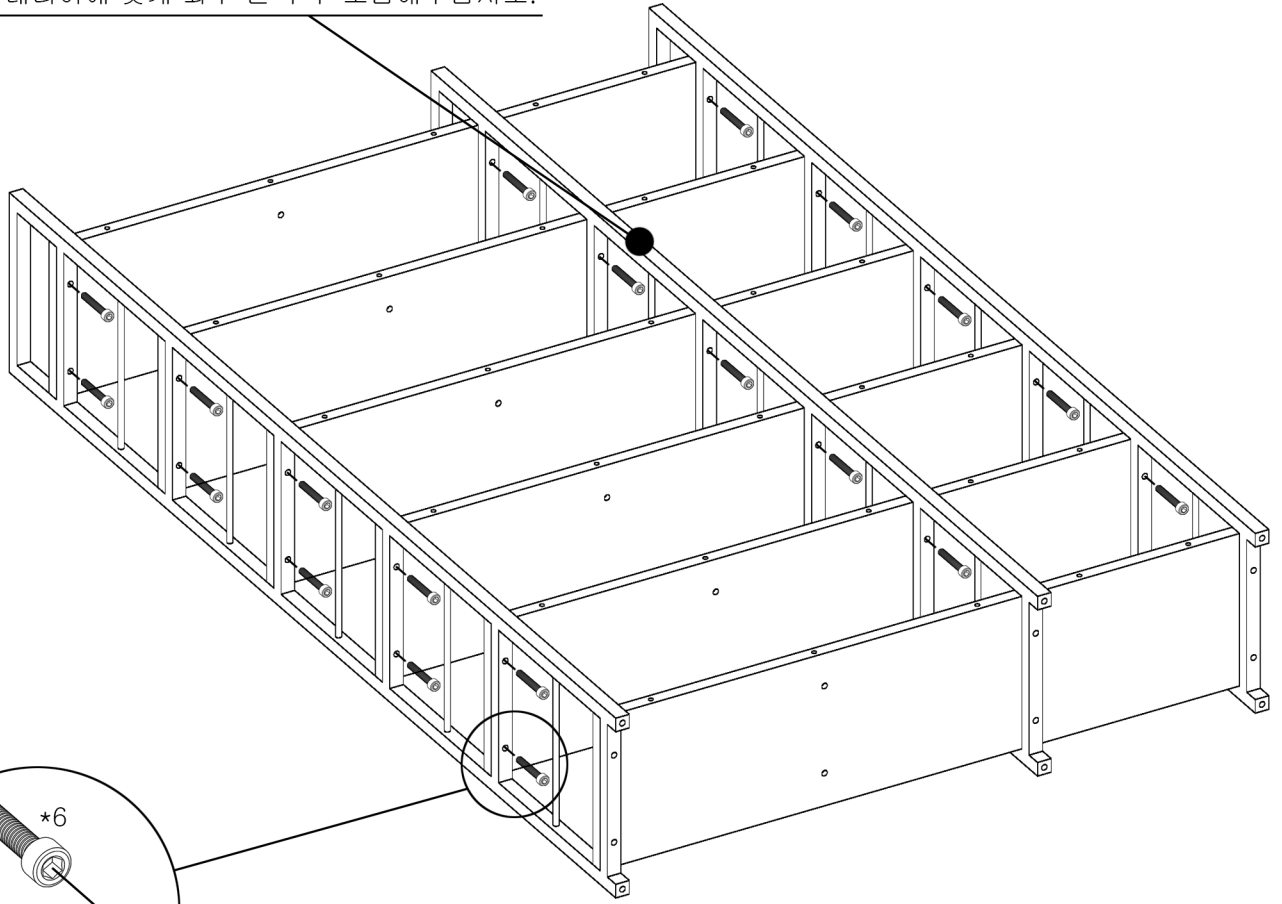

STEP 4

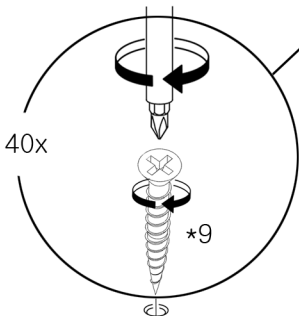
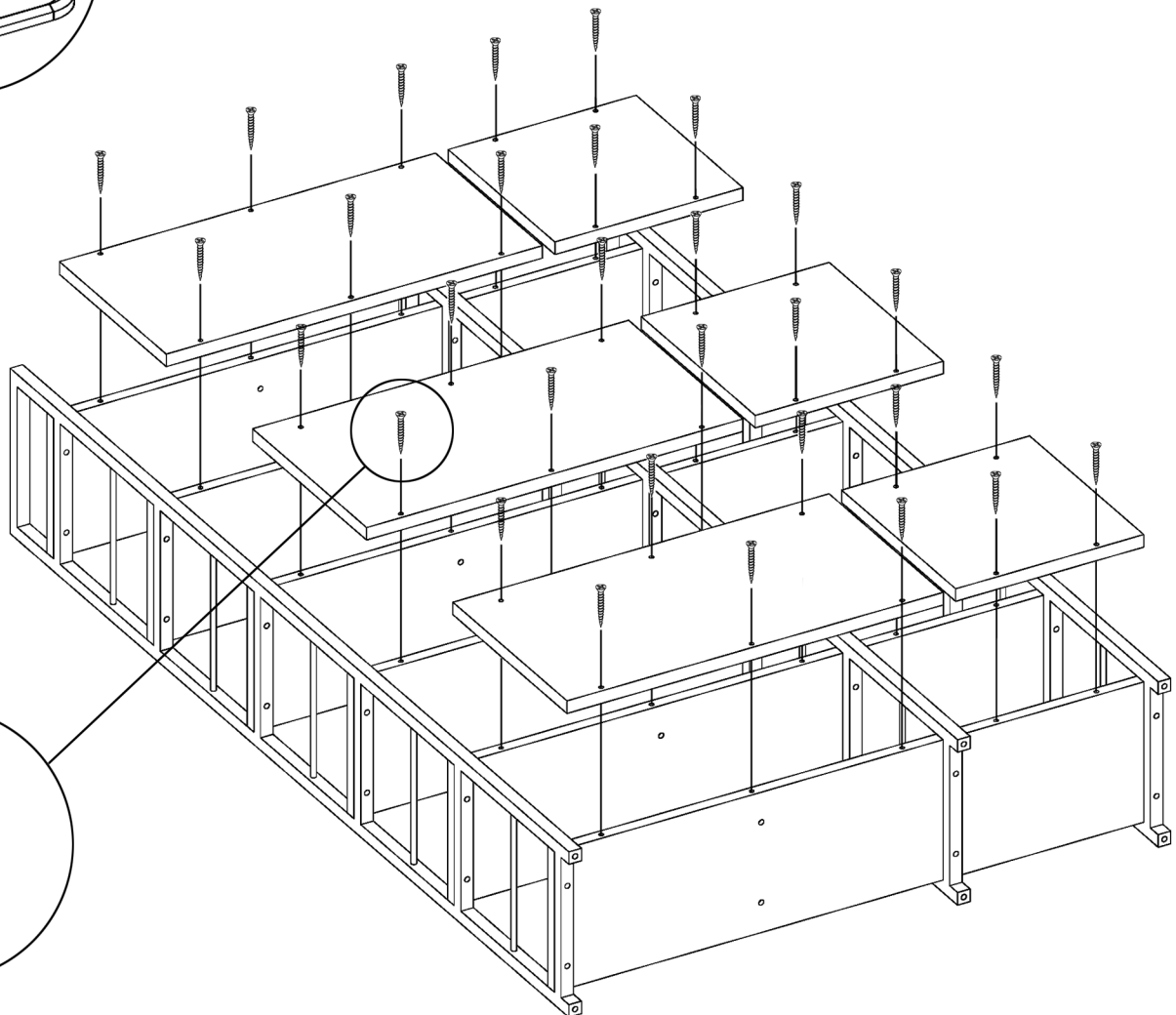

STEP 5

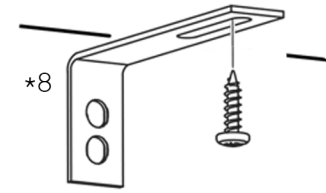

2x

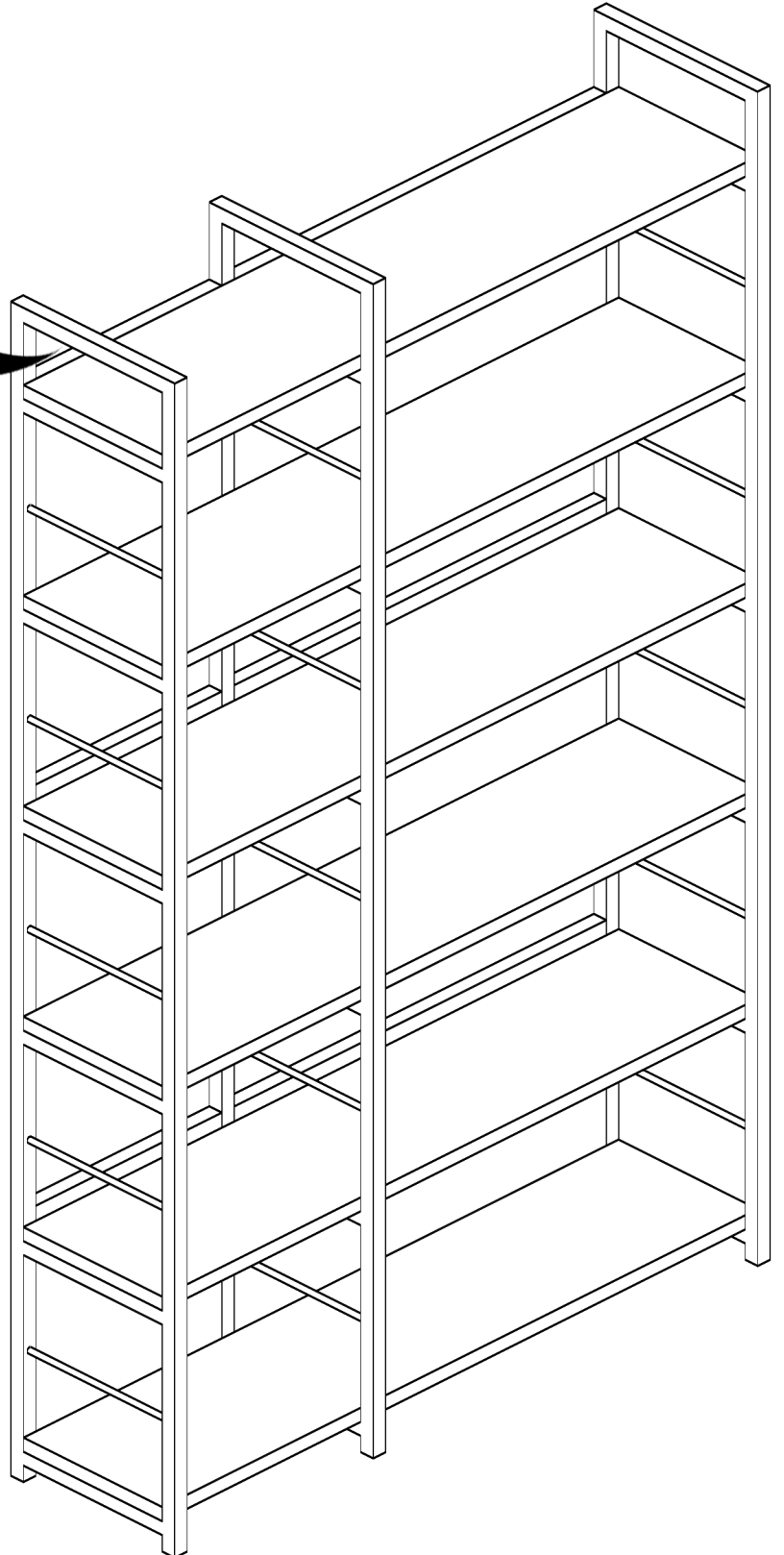
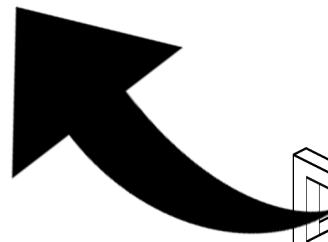
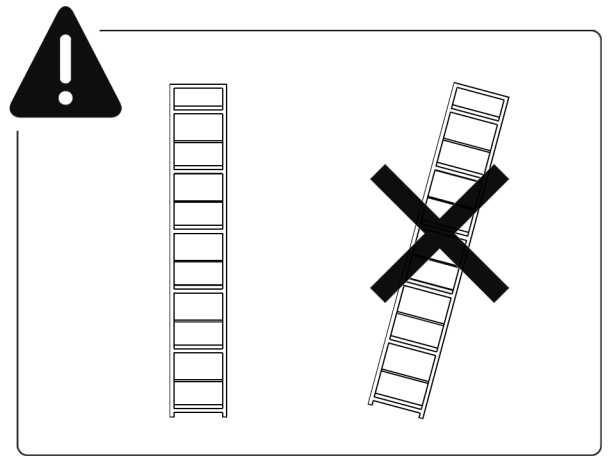
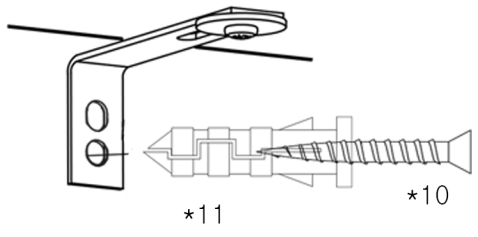

STEP 6

*STEP 6 은 두 개 이상 구매 시 두 제품의 결합을 위해 필요한 부품입니다.

